

	Page Seite
<b>Bit index / Bohrkronenübersicht.....</b>	<b>56-57</b>
Boart.....	60
Böhler.....	60
Bulroc.....	60-61, 63, 65-72
Epiroc.....	61-63, 65-72
Halco.....	61, 63-72
Ingersoll-Rand.....	63-71
Karbo.....	63, 65-66, 68
Mincon.....	62-72
Mission.....	63, 72
Numa.....	63, 65-71
Puma.....	63, 65-72
Rockmore.....	60-71, 73
Sandvik.....	62-63, 65-66, 68, 70-71
Secoroc.....	62, 65-67, 69, 71-72

## Bit index / Bohrkronenübersicht

### Tableau comparatif des taillants / Indice de las brocas

Hammers of different brands can be operated with identical bits i.e. with the same shank design.

Imlochhämmer verschiedener Marken könne mit ein- und derselben Bohrkronen bestückt werden.

Les marteaux fond de trou à marques différentes peuvent être équipés d'un même taillant.

Los martillos de fondo de marcas diferentes pueden ser equipados con las mismas brocas.

DTH Hammer Imlochhammer Marteau fond de trou Martillo para agujeros profundos	Illustration Bild Illustration Ilustración	Page Seite Page Página	DTH Hammer Imlochhammer Marteau fond de trou Martillo para agujeros profundos	Illustration Bild Illustration Ilustración	Page Seite Page Página
<b>BOART</b> DH 75	1.01	60	<b>HALCO</b> DART 350 / DOMINATOR 350 & 375 (DHD 3.5 SHANK)	4.01	63
<b>BÖHLER</b> LH 78 ZD	1.01	60	DOMINATOR 375 (MD 35 SHANK)	5.01	64
<b>BULROC</b> BR2	2.01	61	DART 400 / S. DOMINATOR 400, 450 (DHD 340A SHANK)	6.01	65-66
BR3 (6 splines)	1.01	60	SUPER DOMINATOR 500 / 550 HD (DHD 350 SHANK)	7.01	67
BR33 (7 splines)	2.02	61	SUPER DOMINATOR 550 HD QL 50	8.01	68
HYPER 31 (DHD 3.5 SHANK)	4.01	63	DOMINATOR 600, SUPER DOMINATOR 600, 650 (DHD 360 SHANK)	9.01	69
HYPER 41 (DHD 340A SHANK), 415	6.01	65-66	DOMINATOR 600 SUPER DOMINATOR 650 (SD 6 SHANK)	12.02	72
HYPER 51 / 55 DH (DHD 350R SHANK)	7.01	67	SUPER DOMINATOR 650 HD QL 60	10.01	70
HYPER 55 DH	8.01	68	DOMINATOR 850 QL 80	11.02	71
HYPER 61 / 63 / 63 HD / 66 DH (DHD 360 SHANK)	9.01	69	MACH 20	2.01	61
HYPER 66 DH (QL 60 SHANK)	10.01	70	MACH 80 / 88 (DHD 380 SHANK)	11.01	71
HYPER 81 (DHD 380 SHANK)	11.01	71	DOMINATOR 800 / 880 / 800 DW (DHD 380 SHANK)		
HYPER 81 (QL 80 SHANK)	11.02	71			
BR6	12.02	72			
<b>EPIROC</b> COP 20	2.01	61	<b>INGERSOLL-RAND</b> DHD 3.5	4.01	63
COP 32	3.01	62	DHD 3.5 HD	5.01	64
COP 35 / TD 35.2 / QLX 35 TERRANOX 3	4.01	63	DHD 340A	6.01	65-66
TD 40 / QLX 40 / COP 44 GOLD	3.02	62	DHD 350R	7.01	67
COP 44 / DHD 4 / QL 340 TERRANOX 4	6.01	65-66	QL5 / QL50	8.01	68
COP 54 / DHD 5 TERRANOX 5	7.01	67	DHD 360 / DH6 / SF6 / SF6.5	9.01	69
QL 50 / TD 50 / COP 54 Gold	8.01	68	QL6 / QL60	10.01	70
COP 64 / DHD 6 TERRANOX 6	9.01	69	DHD 380	11.01	71
QL 60 / TD 60 / TD 65 / TD 70 / COP 64 Gold	10.01	70	QL8 / QL80	11.02	71
COP 64M	12.02	72			
COP 84 / DHD 8 TERRANOX	11.01	71			
QL 80 / TD 80 / TD 85	11.02	71			

## Bit index / Bohrkronenübersicht

## Tableau comparatif des taillants / Indice de las brocas

Hammers of different brands can be operated with identical bits i.e. with the same shank design.

Imlochhämmer verschiedener Marken könne mit ein- und derselben Bohrkrone bestückt werden.

Les marteaux fond de trou à marques différentes peuvent être équipés d'un même taillant.

Los martillos de fondo de marcas diferentes pueden ser equipados con las mismas brocas.

DTH Hammer Imlochhammer Marteau fond de trou Martillo para agujeros profundos	Illustration Bild Illustration Ilustración	Page Seite Page Página	DTH Hammer Imlochhammer Marteau fond de trou Martillo para agujeros profundos	Illustration Bild Illustration Ilustración	Page Seite Page Página
<b>KARBO</b> 35A K40 K50	4.01 6.01 8.01	63 65-66 68	<b>PUMA</b> 3.1 (DHD 3.5 SHANK) 4.4 (DHD 340 SHANK) 5.2 (DHD 350 SHANK) 5.2 (QL 5 SHANK) 6.2 / 6.3 (DHD 360 SHANK) 6.2 (QL 60 SHANK) 6.2 / 6.3 (SD 6 SHANK) 8.1 (DHD 380 SHANK) 8.1 (QL 80 SHANK)	4.01 6.01 7.01 8.01 9.01 10.01 12.02 11.01 11.02	63 65-66 67 68 69 70 72 71 71
<b>MINCON</b> 3 & 3.5 MD 35 4 HR MP40 (TD40 SHANK) 5 DH / 5 BH (DHD 350 SHANK) MP50 / 5 DH-QL MQ50 / MP56 (QL5 SHANK) 6 DH 360 6 DH / 6 DH-LV / XP 60 / 6 BH 6 DHSD6 MP60 / MP65 / MQ68 (QL6 SHANK) 8 DH / XP90-380 8.1 (QL 80 SHANK) MP80 / MQ80 / MP85 / MQ85 (QL8 SHANK)	4.01 5.01 6.01 3.02 7.01 8.01 8.01 9.01 10.01 12.02 10.01 11.01 11.02 11.01	63 64 65-66 62 67 68 68 69 70 72 70 71 71 71	<b>ROCKMORE</b> ROK 20LT ROK 3L ROK 30LT ROK 250 ROK 300 / ROK 350 ROK 350HD ROK 400 ROK 400TD ROK 55A-350R ROK 550A ROK 60-360 / ROK 65-360 ROK 600A / ROK 650A / ROK 650M ROK 87A ROK 800A / ROK 875A	2.01 1.01 2.02 13.01 4.01 5.01 6.01 3.02 7.01 8.01 9.01 10.01 11.01 11.02	61 60 61 73 63 64 65-66 62 67 68 69 70 71 71
<b>MISSION</b> MI6 / M60 A 53-15 / SD 6 XL3	12.01 12.02 4.01	72 72 63	<b>SANDVIK</b> RH460 3.5" RH460 4" (DHD 340 SHANK) RH460 4" (TD40 SHANK) RH460 5" / RH460g 5" RH460 6" / RH460g 6" RH460 8" / RH460g 8"	4.01 6.01 3.02 8.01 10.01 11.02	63 65-66 62 68 70 71
<b>NUMA</b> 35 / PATRIOT 35 A CHALLENGER 4 CHAMPION 40 / PATRIOT 40 CHALLENGER 55 PATRIOT 50 / DCS 5 CHALLENGER 6 PATRIOT 60 W PATRIOT 60 WQ CHALLENGER 80 PATRIOT 80	4.01 6.01 7.01 8.01 9.01 10.01 11.01	63 65-66 67 68 69 70 71	<b>SECOROC</b> 3" 4" / 4" Q 5" / 5" Q 6" / 6" Q / 6" QHD 8" 6" M	3.01 6.01 7.01 9.01 11.01 12.02	62 65-66 67 69 71 72

# CARBIDE PROFILE DESIGN

**Carbide Design Selection**

Hemispherical CrownPoint Semi Ballistic Full Ballistic Conical Spike

Hemispherical MultiPoint CrownPoint MultiPoint Semi Ballistic MultiPoint Full Ballistic MultiPoint

**MULTIPOINT**

**ROCK MORE INTERNATIONAL**  
Rock Drilling Tools

# CARBIDE SELECTION / HARTMETALLEINSÄTZE

### Carbide Designs / Hartmetalldesign



Perhaps the most fundamental decision when selecting different carbide configurations is profile shape. Button bits most commonly have either a hemispherical or semi-ballistic carbide design; however it is not uncommon to use other carbide designs as well.

### Carbide Configurations / Hartmetallkonfiguration

Most face designs for button bits are offered in multiple carbide configurations and typically differ in diameter, shape (i.e. profile) and quantity. There are some general guidelines to follow while selecting between multiple carbide configurations include.

Eine der grundlegendsten Entscheidungen bei der Auswahl der Hartmetalleinsätze ist die Stiffform. Tieflochstiftbohrkronen haben meist Kugel- oder Ballistische Stifte. Für viele Anwendungen eignen sich jedoch auch andere Stiffformen.

Die meisten Tieflochstiftbohrkronen werden mit unterschiedlichen Hartmetallstiffformen angeboten. Sie unterscheiden sich im Durchmesser, im Design und in der Anzahl. Es sollten bei der Auswahl der Stifte einige Richtlinien befolgt werden.

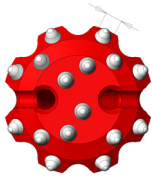
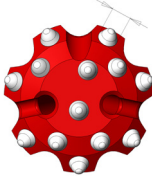
<p><b>FASTER</b> SCHNELLER</p> <p>Shorter lifetime and susceptible to breaks Kürzere Lebensdauer und anfällig für Brüche</p>  <p>CONICAL</p>	<p><b>PENETRATION RATE</b> VORSCHUBRATE</p> <p>Tungsten carbide lifetime. Hartmetallstift Lebensdauer</p>  <p>FULL BALLISTIC</p>	<p><b>SLOWER</b> LANGSAMER</p> <p>Longer lifetime and less susceptible to breaks Längere Lebensdauer und weniger anfällig für Brüche</p>  <p>SEMI BALLISTIC</p>	<p><b>SOFTER</b> WEICHER</p> <p>MORE, SMALLER DIAMETER CARBIDE RESULTS IN FASTER PENETRATION RATES, BUT SHORTER CARBIDE AND BIT LIFE. MEHR STIFTE UND EIN KLEINERER STIFTDURCHMESSER ERGEBEN EINE SCHNELLERE VORSCHUBRATE / VERKÜRZEN ABER DIE LEBENSDAUER DER HARTMETALLEINSÄTZE UND DER BOHRKRONE</p> 	<p><b>ROCK HARDNESS</b> GESTEINSFESTIGKEIT</p> <p>PENETRATION RATE VS. CARBIDE/BIT LIFE VORSCHUBRATE IM VERGLEICH ZU HARTMETALL &amp; BOHRKRONEN-LEBENSDAUER</p> 	<p><b>HARDER</b> HÄRTER</p> <p>FEWER, LARGER DIAMETER CARBIDE RESULTS IN SLOWER PENETRATION RATES, BUT LONGER CARBIDE AND BIT LIFE. WENIGER STIFTE UND EIN GRÖßERER STIFTDURCHMESSER ERGEBEN EINE LANGSAMERE VORSCHUB-RATE / VERLÄNGERN ABER DIE LEBENSDAUER DER HARTMETALLEINSÄTZE UND DER BOHRKRONE</p>
<p><b>LESS</b> WENIGER</p>	<p><b>VIBRATION</b> VIBRATION</p>	<p><b>MORE</b> MEHR</p>			

BIT AND ROD VIBRATION INCREASES WHEN FEWER AND LARGER CARBIDE BUTTONS ARE SELECTED.  
DIE VIBRATION DER BOHRKRONE UND BOHRSTANGE ERHÖHT SICH BEI WENIGER STIFTEN UND GRÖßEREM STIFTDURCHMESSER.

# HEAD PROFILE DESIGN

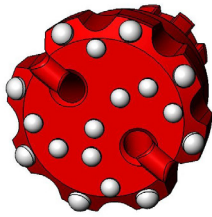

### FLAT FACE

#### Applications / Anwendungen

Hard and abrasive formations, all round.  
Hartes und abrasives Gestein, universell einsetzbar.

#### Typical formations / Typische Gesteinsformationen

Granite, hard limestone, basalt  
Granit, Harter Kalkstein, Basalt

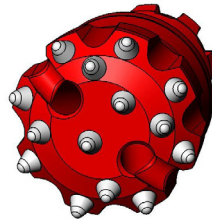

### CONVEX

#### Applications / Anwendungen

Soft to medium hard rock, high penetration rate.  
Weiches bis Mittelhartes Gestein, schneller Bohrfortschritt.

#### Typical formations / Typische Gesteinsformationen

Limestone, hard limestone, shale, granite, basalt  
Kalkstein, Harter Kalkstein, Schiefer, Granit, Basalt

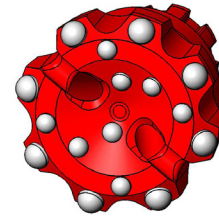

### CONCAVE

#### Applications / Anwendungen

Medium hard to hard formations, less abrasive, fractured formations, excellent control over hole deviation.  
Mittelhartes bis hartes Gestein, leicht abrasive, klüftige Gesteinsformationen, geringe Bohrabweichungen.

#### Typical formations / Typische Gesteinsformationen

Granite, basalt  
Granit, Basalt

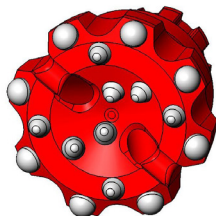

### CONCAVE KUPA

#### Applications / Anwendungen

Special design with ballistic front buttons, medium hard to hard formations, fractured formations.  
Spezielles Design mit ballistischen Stiften an der Stirnseite, Mittelhartes bis Hartes Gestein, klüftige Gesteinsformationen.

#### Typical formations / Typische Gesteinsformationen

Granite, basalt  
Granit, Basalt

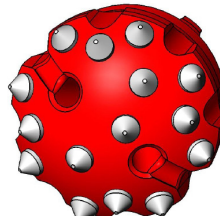

### SPHERICAL / KUGEL

#### Applications / Anwendungen

Special design with spike buttons, appropriate for low pressure hammers in soft rock formations.  
Spezielles Design mit Kegelstiften, geeignet für Niederdruck Hämmer in weichen Gesteinsformationen.

#### Typical formations / Typische Gesteinsformationen

Limestone  
Kalkstein

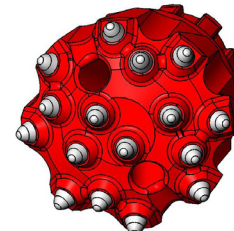

### HEDGEHOG / IGEL

#### Applications / Anwendungen

Special design with better drill chip output at the bit front and with retracts on the bit shoulder for easily lifting.

Spezielles Design mit besseren Bohrkleinausbringung an der Kronenfront und mit Rückschneiden an den Stifschultern um beim Ziehen leichter die Kronen freizuschneiden.

#### Typical formations / Typische Gesteinsformationen

Limestone, hard limestone  
Kalkstein, harter Kalkstein

LESS  
WENIGER

ABRASIVE ROCK  
ABRASIVES GESTEIN

MORE  
MEHR

#### Concave Face

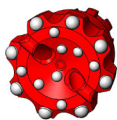

Concave Face designed for unconsolidated or broken rock. These face features will help drill straighter holes in medium to hard formations.

Concave - Kronen verwendet man für nicht verfestigtes und brüchiges Gestein. Diese Kopfform unterstützt geradlinigeres Bohren in mittlerem und hartem Gestein.

#### Concave-Convex

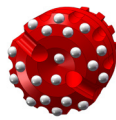

Convex/Concave Face bits are a hybrid design for fast penetration and straighter holes in unconsolidated rock with low silica content. Typical applications are medium to hard formations.

Convex/Concave - Kronen bestehen aus einem gemischten Kopfdesign für eine schnellere Vorschubrate und für geradlinigeres Bohren in nicht verfestigen Gestein mit wenig Quarzanteil. Typische Anwendung in mittlerem und hartem Gestein.

#### Convex Face



Convex Face bits are designed for fast penetration rates in softer rock like shale and limestone with low silica content.

Convex - Kronen sind speziell für hohe Vorschubraten in weichem Gestein wie z.B. Schiefer oder Kalkstein mit niedrigem Quarzanteil.

#### Flat Face

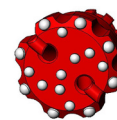

Flat Face bits are a general purpose bit that will work in all rock conditions but should be used especially for hard or abrasive conditions like granite, basalt, and hard limestone. Flat face bits are the best choice for drilling in a high silica environment.

Flat Face - Kronen sind universell einsetzbar. Diese Kopfform kann in sämtlichen Gesteinsarten und diversen Anwendungen eingesetzt werden. Grundsätzlich sollten sie jedoch vorwiegend in Hartgestein oder abrasiven Gesteinen eingesetzt werden wie z.B. Granit, Basalt oder hartem Kalkstein. Flat Face - Kronen eignen sich auch für sehr quarzhaltige Umgebungen.

Button bits are 1-2 mm bigger in diameter than the measurements in the catalogue.  
Stiftbohrkronen sind 1-2 mm größer als das Nennmaß im Katalog.  
Les dimensions des taillants à métal dur sont de 1 à 2 mm plus grandes que celles indiquées dans le catalogue.  
Las medidas de las broca con botones son 1-2 mm más grandes que las medidas del catálogo.

## BÖHLER LH 78 ZD ROCKMORE ROK 3L

BOART DH 75, BULROC BR3 (6 Splines)

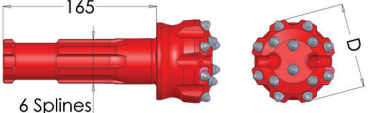
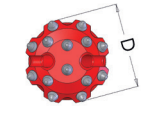
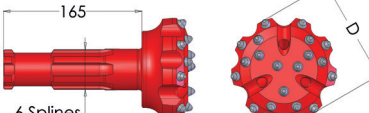
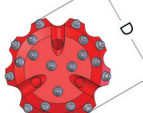
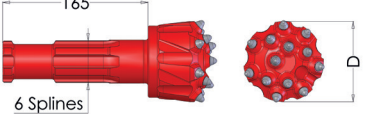
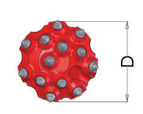
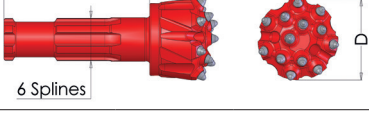
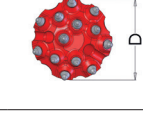
Head design Kopfdesign Façon de tête Tipo de cara	Illustration Bild Illustration Ilustración	Carbide dimension / Hartmetallabmessung Dimension métal dur / Dimension metal duro				D		Weight Gewicht Poids Peso [kg]	Part No. Artikel Nr. N° de réf. Cat. N°	
		Carbide design	Gauge/Umfang extérieur/exterior		Front/Stirnseite front/frontal		[mm]			[in]
			[No.]	[mm]	[No.]	[mm]				
CONVEX 	1.01 	BAL	8	11	6	11	85	3 3/8"	3.55	A41245
		HEM	8	12	6	12	90	3 1/2"	3.50	A41216
		BAL	8	11	8	11	90	3 1/2"	4.01	A41215
		BAL HD	8	12	6	12	90	3 1/2"	3.80	A41238
		CON	8	12	6	12	90	3 1/2"	3.70	A41233
		HEM	8	12	6	12	95	3 3/4"	3.80	A41237
		BAL	8	12	6	12	95	3 3/4"	3.90	A41234
		HEM	8	12	8	12	105	4 1/8"	4.65	A41239
		BAL	8	12	8	12	105	4 1/8"	4.65	A41232
		BAL	8	12	8	12	110 *	4 5/16"	4.95	A41268
		BAL	8	12	9	12	115 *	4 1/2"	5.30	A41235
		BAL	8	12	9	12	120 *	4 23/32"	5.40	A41282
		BAL	9	12	11	12	125 *	4 15/16"	5.50	A41293
		CONVEX 		BAL	7	11	6	11	90	3 1/2"
HEDGEHOG 		BAL	7	11	6	11	90	3 1/2"	4.26	A45413
HEDGEHOG 										

HEM = Hemispherical button / Kugelstift / Boutons hémisphériques / Botones esféricos

BAL = Ballistic carbide / Parabolstift / Boutons paraboliques / Botones parabólicos

CON = Conical carbide on request / Deltastift auf Anfrage / Boutons delta sur demande / Botones conicos a solicitud



KEG = Spike carbide / Kegelstift / Boutons cône / Botones cono

MP = MultiPoint carbide on request / MultiPoint Stift auf Anfrage / Boutons MultiPoint sur demande / Botones MultiPoint a solicitud

\* = No shank breakage warranty / Keine Garantie gegen Schaffbruch / Pas de garantie en cas de rupture du tige / Ninguna garantía en caso de rotura de la varilla

## BULROC BR2 ROCKMORE ROK 20LT

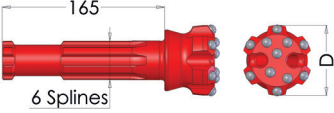
EPIROC COP 20, HALCO MACH 20

Head design Kopfdesign Façon de tête Tipo de cara	Illustration Bild Illustration Ilustración	Carbide dimension / Hartmetallabmessung Dimension métal dur / Dimension metal duro				D		Weight Gewicht Poids Peso	Part No. Artikel Nr. N° de réf. Cat. N°	
		Carbide design	Gauge/Umfang extérieur/exterior		Front/Stirnseite front/frontal		[mm]			[in]
			[No.]	[mm]	[No.]	[mm]				
FLAT FACE 	<b>2.01</b> 	HEM	6	10	5	10	70	2 3/4"	2.30	A45135
		CON	6	10	5	10	70	2 3/4"	2.30	A45180
		HEM	6	11	5	11	76	3"	2.60	A45087
		HEM/BAL	6	11	5	11	76	3"	2.60	A45088
		BAL	6	11	5	11	76	3"	2.60	A45089

## BULROC BR33 (7 splines) ROCKMORE ROK 30LT

Head design Kopfdesign Façon de tête Tipo de cara	Illustration Bild Illustration Ilustración	Carbide dimension / Hartmetallabmessung Dimension métal dur / Dimension metal duro				D		Weight Gewicht Poids Peso	Part No. Artikel Nr. N° de réf. Cat. N°	
		Carbide design	Gauge/Umfang extérieur/exterior		Front/Stirnseite front/frontal		[mm]			[in]
			[No.]	[mm]	[No.]	[mm]				
CONVEX 	<b>2.02</b> 	HEM	8	12	6	12	90	3 1/2"	3.50	A45463
		BAL	8	12	6	12	90	3 1/2"	4.12	A45162
		CON	8	11	6	11	90	3 1/2"	4.00	A45164
		HEM	8	12	6	12	95	3 3/4"	3.80	A45459
		BAL	8	12	6	12	95	3 3/4"	3.80	A45460
		HEM	8	12	8	12	105	4 1/8"	4.65	A45461
BAL	8	12	8	12	105	4 1/8"	4.65	A45462		

HEM = Hemispherical button / Kugelstift / Boutons hémisphériques / Botones esféricos

BAL = Ballistic carbide / Parabolstift / Boutons paraboliques / Botones parabólicos

CON = Conical carbide on request / Deltastift auf Anfrage / Boutons delta sur demande / Botones conicos a solicitud

MP = MultiPoint carbide on request / MultiPoint Stift auf Anfrage / Boutons MultiPoint sur demande / Botones MultiPoint a solicitud

## EPIROC COP 32

SECOROC 3"

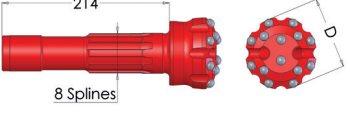
Head design Kopfdesign Façon de tête Tipo de cara	Illustration Bild Illustration Ilustración	Carbide dimension / Hartmetallabmessung Dimension métal dur / Dimension metal duro				D		Weight Gewicht Poids Peso [kg]	Part No. Artikel Nr. N° de réf. Cat. N°	
		Carbide design	Gauge/Umfang extérieur/exterior		Front/Stirnseite front/frontal		[mm]			[in]
			[No.]	[mm]	[No.]	[mm]				
CONVEX 	3.01	BAL	8	11	6	11	85	3 3/8"	3.70	A45133
		HEM	8	12	6	12	90	3 1/2"	4.20	A45079
		BAL	8	12	6	12	90	3 1/2"	4.60	A41248

## EPIROC TD 40 / QLX 40 / COP 44 GOLD ROCKMORE ROK 400TD

MINCON MP40 (TD40 shank), SANDVIK RH460 4"

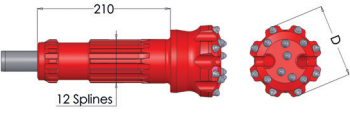
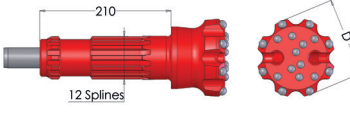
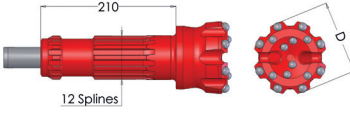
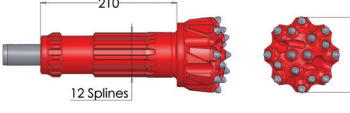
CONVEX 	3.02	BAL	8	14	7	13	110	4 5/16"	8.00	A45585
		BAL	8	13	8	13	115	4 1/2"	9.30	A45586
		BAL HD	8	14	7	13	115	4 1/2"	9.30	A45593
		BAL	8	14	8	13	120	4 23/32"	9.50	A45587
		BAL	8	14	9	13	125	4 15/16"	9.80	A45588
		BAL	8	14	10	13	130 *	5 1/8"	10.20	A45589
FLAT FACE 		HEM	8	14	7	12	110	4 5/16"	9.10	A45595
		HEM	8	14	8	12	115	4 1/2"	9.30	A45574
		HEM HD	8	16	6	14	115	4 1/2"	9.30	A45598
		HEM	8	14	8	12	120	4 23/32"	9.50	A45596
		HEM	8	14	10	12	125	4 15/16"	9.80	A45556
		HEM	8	14	8	14	130 *	5 1/8"	10.20	A45597
CONCAVE 		HEM	8	14	8	12	115	4 1/2"	9.10	A45600
		HEM/BAL	8	14	8	12	115	4 1/2"	9.10	A45604
		HEM	8	16	8	12	125	4 15/16"	9.80	A45601
		HEM/BAL	8	16	8	12	125	4 15/16"	9.80	A45605
		HEM	8	16	8	12	130 *	5 1/8"	10.20	A45602
		HEM/BAL	8	16	8	12	130 *	5 1/8"	10.20	A45606
HEDGEHOG 		BAL	8	13	8	12	115	4 1/2"	9.10	A45608
Blow tube / Fußventil Soupape inférieure / Válvula de pie									A45093	

HEM = Hemispherical button / Kugelstift / Boutons hémisphériques / Botones esféricos

BAL = Ballistic carbide / Parabolstift / Boutons paraboliques / Botones parabólicos

CON = Conical carbide on request / Deltastift auf Anfrage / Boutons delta sur demande / Botones conicos a solicitud

MP = MultiPoint carbide on request / MultiPoint Stiff auf Anfrage / Boutons MultiPoint sur demande / Botones MultiPoint a solicitud

\* = No shank breakage warranty / Keine Garantie gegen Schaftbruch / Pas de garantie en cas de rupture du tige / Ninguna garantía en caso de rotura de la varilla



## INGERSOLL-RAND DHD 3.5 ROCKMORE ROK 300 / ROK 350

EPIROC COP 35 / TD 35.2 / QLX 35 / TERRANOX 3, **BULROC** HYPER 31 (DHD 3.5 shank), **HALCO** DART 350 / DOMINATOR 350 & 375 (DHD 3.5 shank),  
**KARBO** 35A, **MINCON** 3 & 3.5, **MISSION** XL3, **NUMA** 35 / PATRIOT 35 A, **PUMA** 3.1 (DHD 3.5 shank), **SANDVIK** RH460 3.5\*

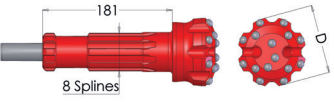
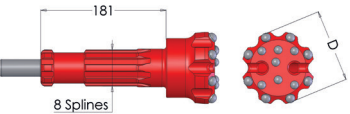
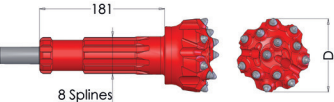
Head design Kopfdesign Façon de tête Tipo de cara	Illustration Bild Illustration Ilustración	Carbide dimension / Hartmetallabmessung Dimension métal dur / Dimension metal duro				D		Weight Gewicht Poids Peso	Part No. Artikel Nr. N° de réf. Cat. N°			
		Carbide design	Gauge/Umfang extérieur/exterior		Front/Stirnseite front/frontal		[mm]			[in]		
			[No.]	[mm]	[No.]	[mm]						
CONVEX 	4.01	CON	8	11	6	11	85	3 3/8"	4.20	A45134		
		HEM	8	12	6	12	92	3 5/8"	4.50	A45070		
		HEM/BAL	8	12	6	12	92	3 5/8"	4.50	A45398		
		BAL	8	11	8	11	92	3 5/8"	4.50	A45278		
		BAL HD	8	12	6	12	92	3 5/8"	4.60	A45137		
		CON	8	12	6	12	92	3 5/8"	4.50	A45497		
		HEM	8	12	6	12	95	3 3/4"	4.70	A45291		
		HEM/BAL	8	12	6	12	95	3 3/4"	4.70	A45496		
		BAL	8	12	6	12	95	3 3/4"	4.70	A45290		
		CON	8	12	6	12	95	3 3/4"	4.70	A45412		
		HEM	8	12	7	12	100	3 15/16"	4.94	A45263		
		BAL	8	12	7	12	100	3 15/16"	4.95	A45169		
		HEM	8	12	8	12	105	4 1/8"	5.40	A45293		
		BAL	8	12	8	12	105	4 1/8"	5.40	A45292		
		FLAT FACE 		HEM	8	14	7	12	105	4 1/8"	5.40	A45196
		HEDGEHOG 		BAL	7	11	6	11	92	3 5/8"	4.72	A45493
	BAL		7	12	6	12	95	3 3/4"	4.90	A45494		
	BAL		7	12	6	12	100	3 15/16"	5.16	A45524		
	BAL		7	12	6	12	105	4 1/8"	5.30	A45528		
Blow tube / Fußventil Soupape inférieure / Válvula de pie										A45099		

HEM = Hemispherical button / Kugelstift / Boutons hémisphériques / Botones esféricos

BAL = Ballistic carbide / Parabolstift / Boutons paraboliques / Botones parabólicos

CON = Conical carbide on request / Deltastift auf Anfrage / Boutons delta sur demande / Botones conicos a solicitud

MP = MultiPoint carbide on request / MultiPoint Stift auf Anfrage / Boutons MultiPoint sur demande / Botones MultiPoint a solicitud

## INGERSOLL-RAND DHD 3.5 HD ROCKMORE ROK 350HD



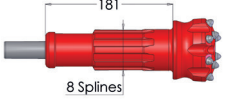
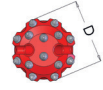
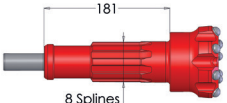
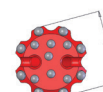
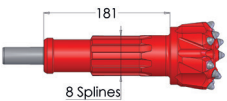
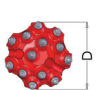



HALCO DOMINATOR 375 (MD 35 shank), MINCON MD 35

Head design Kopfdesign Façon de tête Tipo de cara	Illustration Bild Illustration Ilustración	Carbide dimension / Hartmetallabmessung Dimension métal dur / Dimension metal duro				D		Weight Gewicht Poids Peso	Part No. Artikel Nr. N° de réf. Cat. N°			
		Carbide design	Gauge/Umfang extérieur/exterior		Front/Stirnseite front/frontal		[mm]			[in]		
			[No.]	[mm]	[No.]	[mm]						
<b>CONVEX</b> 	<b>5.01</b> 	HEM	8	12	6	12	95	3 3/4"	5.00	A45331		
		HEM/BAL	8	12	6	12	95	3 3/4"	5.10	A45468		
		BAL	8	12	6	12	95	3 3/4"	5.05	A45330		
		CON	8	12	6	12	95	3 3/4"	5.10	A45498		
		HEM	8	12	7	12	100	3 15/16"	5.32	A45333		
		HEM/BAL	8	12	7	12	100	3 15/16"	5.32	A45538		
		BAL	8	12	7	12	100	3 15/16"	5.40	A45332		
		CON	8	12	7	12	100	3 15/16"	5.30	A45523		
		HEM/BAL	8	12	8	12	105	4 1/8"	5.40	A45336		
		BAL	8	12	8	12	105	4 1/8"	5.40	A45334		
		BAL HD	7	14	6	14	105	4 1/8"	5.80	A45469		
		CON	8	12	8	12	105	4 1/8"	5.40	A45642		
		<b>FLAT FACE</b> 		HEM	8	14	7	12	105	4 1/8"	5.45	A45335
		<b>HEDGEHOG</b> 		BAL	7	12	6	12	95	3 3/4"	5.34	A45495
BAL	7			12	6	12	100	3 15/16"	5.30	A45650		
BAL	7			12	7	12	105	4 1/8"	5.40	A45633		
Blow tube / Fußventil Soupape inférieure / Válvula de pie									A45099			

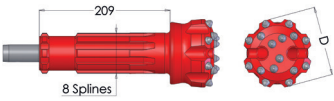
HEM = Hemispherical button / Kugelstift / Boutons hémisphériques / Botones esféricos  
 BAL = Ballistic carbide / Parabolstift / Boutons paraboliques / Botones parabólicos  
 CON = Conical carbide on request / Deltastift auf Anfrage / Boutons delta sur demande / Botones conicos a solicitud  
 MP = MultiPoint carbide on request / MultiPoint Stift auf Anfrage / Boutons MultiPoint sur demande / Botones MultiPoint a solicitud

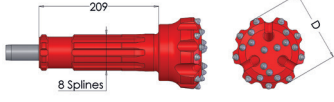
## INGERSOLL-RAND DHD 340A ROCKMORE ROK 400

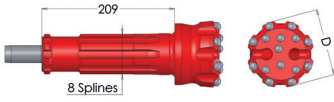
EPIROC COP 44 / DHD 4 / QL 340 / TERRANOX 4, **BULROC** HYPER 41 (DHD 340A shank), HYPER 415, **HALCO** DART 400 / SUPER DOMINATOR 400, 450 (DHD 340A shank), **KARBO** K40, **MINCON** 4 HR, **NUMA** CHALLENGER 4 / CHAMPION 40 / PATRIOT 40, **PUMA** 4.4 (DHD 340A shank), **SANDVIK** RH460 4°, **SECOROC** 4° / 4° Q

Head design Kopfdesign Façon de tête Tipo de cara	Illustration Bild Illustration Ilustración	Carbide dimension / Hartmetallabmessung Dimension métal dur / Dimension metal duro				D		Weight Gewicht Poids Peso [kg]	Part No. Artikel Nr. N° de réf. Cat. N°	
		Carbide design	Gauge/Umfang extérieure/exterior		Front/Stirnseite front/frontal		[mm]			[in]
			[No.]	[mm]	[No.]	[mm]				
CONVEX 	6.01 	HEM	8	14	8	12	105	4 1/8"	7.60	A41276
		BAL	8	12	8	12	105	4 1/8"	7.50	A45167
		HEM	8	14	8	12	110	4 5/16"	7.80	A41287
		BAL	8	12	8	12	110	4 5/16"	7.80	A41294
		BAL HD	8	13	8	13	110	4 5/16"	7.80	A45443
		HEM	8	14	8	12	115	4 1/2"	8.10	A41278
		HEM/BAL	8	14	8	12	115	4 1/2"	8.10	A45636
		BAL	8	12	9	12	115	4 1/2"	8.10	A45075
		BAL	8	13	8	13	115	4 1/2"	8.10	A45067
		BAL HD	7	14	7	14	115	4 1/2"	8.62	A45431
		CON	8	12	9	12	115	4 1/2"	8.10	A45575
		BAL	8	14	8	12	120	4 23/32"	8.10	A45550
		HEM	8	14	9	14	130 *	5 1/8"	9.30	A45149
		HEM HD	8	16	9	14	140 *	5 1/2"	11.10	A45151
		BAL HD	8	16	9	14	145 *	5 45/64"	11.60	A45328
CONVEX 		BAL	9	12	12	12	127 *	5"	8.75	A45074
		HEM/BAL	9	12	12	12	130 *	5 1/8"	9.30	A45641
		BAL	9	12	12	12	130 *	5 1/8"	9.15	A45150
		BAL	9	14	12	12	140 *	5 1/2"	10.20	A45152
FLAT FACE 		HEM	8	14	7	12	105	4 1/8"	7.70	A45032
		HEM	8	14	8	12	110	4 5/16"	8.15	A45069
		HEM	8	14	8	12	115	4 1/2"	8.50	A45066
		HEM HD	8	16	6	14	115	4 1/2"	8.50	A45411
		HEM/BAL	8	14	8	12	115	4 1/2"	8.50	A45517
		HEM	8	14	8	12	120	4 23/32"	9.00	A45341
		HEM	8	14	9	12	127 *	5"	9.15	A45165
		HEM	8	14	9	12	130 *	5 1/8"	9.20	A45195
		HEM HD	8	16	9	14	140 *	5 1/2"	11.10	A45033
		HEM HD	8	16	9	14	145 *	5 45/64"	11.50	A45307
		HEM	8	16	9	14	150 *	5 7/8"	12.00	A45260
		Blow tube / Fußventil Soupape inférieure / Válvula de pie								

HEM = Hemispherical button / Kugelstift / Boutons hémisphériques / Botones esféricos

BAL = Ballistic carbide / Parabolstift / Boutons paraboliques / Botones parabólicos

CON = Conical carbide on request / DeltaStift auf Anfrage / Boutons delta sur demande / Botones conicos a solicitud

MP = MultiPoint carbide on request / MultiPoint Stift auf Anfrage / Boutons MultiPoint sur demande / Botones MultiPoint a solicitud

\* = No shank breakage warranty / Keine Garantie gegen Schaftbruch / Pas de garantie en cas de rupture du tige / Ninguna garantía en caso de rotura de la varilla

# INGERSOLL-RAND DHD 340A ROCKMORE ROK 400

EPIROC COP 44 / DHD 4 / QL 340 / TERRANOX 4, **BULROC** HYPER 41 (DHD 340A shank), HYPER 415  
 HALCO DART 400 / SUPER DOMINATOR 400, 450 (DHD 340A shank), **KARBO** K40, **MINCON** 4 HR  
 NUMA CHALLENGER 4 / CHAMPION 40 / PATRIOT 40, **PUMA** 4.4 (DHD 340A shank), **SANDVIK** RH460 4", **SECOROC** 4" / 4" Q

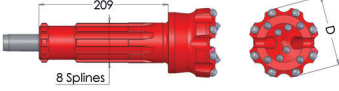
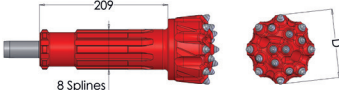
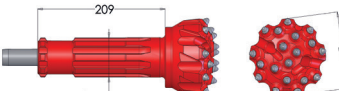







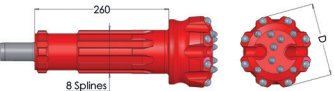

Head design Kopfdesign Façon de tête Tipo de cara	Illustration Bild Illustration Ilustración	Carbide dimension / Hartmetallabmessung Dimension métal dur / Dimension metal duro				D		Weight Gewicht Poids Peso [kg]	Part No. Artikel Nr. N° de réf. Cat. N°	
		Carbide design	Gauge/Umfang extérieur/exterior [No.] [mm]		Front/Stirnseite front/frontal [No.] [mm]		[mm]			[in]
CONCAVE 	6.01	HEM	8	14	8	12	105	4 1/8"	7.60	A45034
		HEM	8	14	8	12	110	4 5/16"	8.60	A45035
		HEM/BAL	8	14	8	12	110	4 5/16"	8.00	A45516
		HEM	8	14	8	12	115	4 1/2"	8.10	A45212
		HEM/BAL	8	14	8	12	115	4 1/2"	8.80	A45425
		HEM	8	14	8	12	120	4 23/32"	9.00	A45192
		HEM/BAL	8	14	8	12	120	4 23/32"	8.80	A45508
		HEM	8	16	8	12	127 *	5"	9.05	A45213
		HEM/BAL	8	16	8	12	127 *	5"	9.05	A45424
		HEM	8	16	8	12	130 *	5 1/8"	9.10	A45193
		HEM/BAL	8	16	8	12	130 *	5 1/8"	9.10	A45437
		HEM	8	16	8	14	140 *	5 1/2"	11.00	A45214
		HEM/BAL	8	16	8	14	140 *	5 1/2"	11.00	A45644
HEDGEHOG 		BAL	8	13	8	12	110	4 5/16"	7.90	A45539
		BAL	8	13	8	12	115	4 1/2"	7.99	A45499
		BAL	8	13	8	12	120	4 23/32"	8.50	A45567
HEDGEHOG 		BAL	9	12	10	12	127 *	5"	9.00	A45531
Blow tube / Fußventil Soupape inférieure / Válvula de pie									A45094	

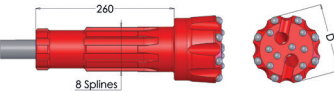
HEM = Hemispherical button / Kugelstift / Boutons hémisphériques / Botones esféricos  
 BAL = Ballistic carbide / Parabolstift / Boutons paraboliques / Botones parabólicos  
 CON = Conical carbide on request / Deltastift auf Anfrage / Boutons delta sur demande / Botones conicos a solicitud  
 MP = MultiPoint carbide on request / MultiPoint Stift auf Anfrage / Boutons MultiPoint sur demande / Botones MultiPoint a solicitud  
 \* = No shank breakage warranty / Keine Garantie gegen Schaftbruch / Pas de garantie en cas de rupture du tige / Ninguna garantía en caso de rotura de la varilla

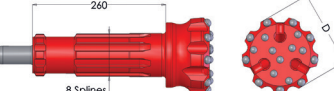
# INGERSOLL-RAND DHD 350R

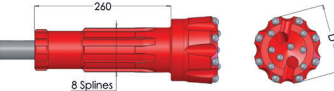
## ROCKMORE ROK 55A-350R

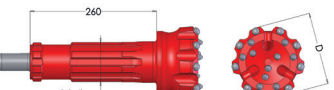
EPIROC COP 54 / DHD 5 / TERRANOX 5, BULROC HYPER 51 / 55DH (DHD 350 shank), HALCO SUPER DOMINATOR 500 / 550 HD (DHD 350 shank)  
MINCON 5 DH / 5 BH (DHD 350 shank), NUMA CHALLENGER 55, PUMA 5.2 (DHD 350 shank), SECOROC 5" / 5" Q

Head design Kopfdesign Façon de tête Tipo de cara	Illustration Bild Illustration Ilustración	Carbide dimension / Hartmetallabmessung Dimension métal dur / Dimension metal duro				D		Weight Gewicht Poids Peso [kg]	Part No. Artikel Nr. N° de réf. Cat. N°	
		Carbide design	Gauge/Umfang extérieure/exterior [No.] [mm]	Front/Stirnseite front/frontal [No.] [mm]		[mm]	[in]			
CONVEX 	7.01 	BAL	8	16	6	16	127	5"	15.85	A45520
		BAL	8	16	8	16	140	5 1/2"	15.90	A45403
		BAL	8	16	9	14	146	5 3/4"	16.60	A45394
FLAT FACE 		HEM	8	16	8	14	130	5 1/8"	14.60	A45166
		HEM	8	16	7	14	135	5 5/16"	15.70	A45549
		HEM	8	16	8	14	140	5 1/2"	15.90	A45086
		HEM	8	16	8	16	145	5 45/64"	16.60	A45664
		HEM	8	16	8	16	146	5 3/4"	16.60	A45216
		HEM	8	16	8	16	150	5 7/8"	17.20	A45184
		HEM	8	16	8	16	152 *	6"	18.00	A45344
		HEM	8	16	10	16	165 *	6 1/2"	18.80	A45673
FLAT FACE 		HEM	9	16	9	14	135	5 5/16"	16.70	A45566
		HEM	9	16	9	14	150	5 7/8"	17.20	A45573
CONCAVE 		HEM	8	16	8	12	127	5"	14.50	A45217
		HEM	8	16	8	12	130	5 1/8"	14.60	A45218
		HEM/BAL	8	16	8	12	130	5 1/8"	14.60	A45467
		HEM/BAL	8	16	7	14	135	5 5/16"	15.70	A45548
		HEM	8	16	8	14	140	5 1/2"	15.90	A45219
		HEM	8	16	8	16	146	5 3/4"	17.10	A45220
		HEM	8	16	9	14	150	5 7/8"	17.50	A45345
		HEM/BAL	8	16	9	14	150	5 7/8"	16.10	A45643
		HEM	8	16	9	14	152 *	6"	17.20	A45346
		HEM/BAL	8	16	9	16	152 *	6"	17.20	A45559
		HEM	8	16	9	16	165 *	6 1/2"	18.80	A45529
		HEM	10	16	12	16	180 *	7"	25.00	A45410
		CONCAVE 		HEM/BAL	9	16	9	14	130	5 1/8"
HEM/BAL	9			14	9	14	135	5 5/16"	15.70	A45702
HEM/BAL	9			16	10	14	150	5 7/8"	16.90	A45695
Blow tube / Fußventil Soupape inférieure / Válvula de pie									A45101	

HEM = Hemispherical button / Kugelstift / Boutons hémisphériques / Botones esféricos

BAL = Ballistic carbide / Parabolstift / Boutons paraboliques / Botones parabólicos

CON = Conical carbide on request / Deltastift auf Anfrage / Boutons delta sur demande / Botones conicos a solicitud

MP = MultiPoint carbide on request / MultiPoint Stift auf Anfrage / Boutons MultiPoint sur demande / Botones MultiPoint a solicitud

\* = No shank breakage warranty / Keine Garantie gegen Schaftbruch / Pas de garantie en cas de rupture du tige / Ninguna garantía en caso de rotura de la varilla

## INGERSOLL-RAND QL5 / QL50 ROCKMORE ROK 550A

EPIROC QL 50 / TD 50 / COP 54 GOLD, BULROC HYPER 55 DH, HALCO SUPER DOMINATOR 550 HD QL50, KARBO K50  
MINCON MQ50, MP50 / 5 DH-QL, MP56, NUMA PATRIOT 50 / DCS 5, PUMA 5.2 (QL 5 shank), SANDVIK RH460 / RH460g 5"

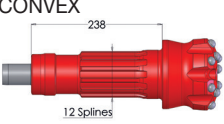
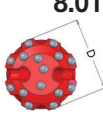
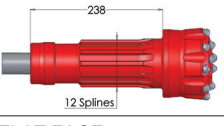
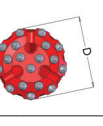
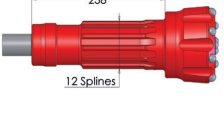
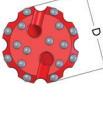
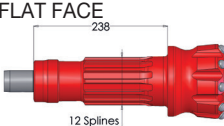
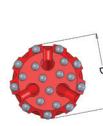
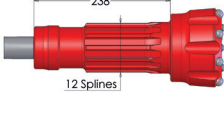
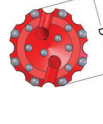
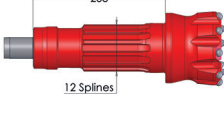
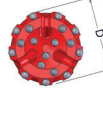
Head design Kopfdesign Façon de tête Tipo de cara	Illustration Bild Illustration Ilustración	Carbide dimension / Hartmetallabmessung Dimension métal dur / Dimension metal duro				D		Weight Gewicht Poids Peso [kg]	Part No. Artikel Nr. N° de réf. Cat. N°	
		Carbide design	Gauge/Umfang extérieure/exterior [No.] [mm]	Front/Stirnseite front/frontal [No.] [mm]		[mm]	[in]			
CONVEX 	8.01 	BAL	8	16	6	16	130	5 1/8"	15.80	A45506
		BAL	8	16	7	16	135	5 5/16"	15.80	A45507
		BAL	8	16	7	16	140	5 1/2"	16.72	A45522
CONVEX 		BAL	9	14	9	16	130	5 1/8"	15.80	A45547
		BAL	9	14	10	14	135	5 5/16"	15.80	A45662
		BAL	9	14	10	14	140	5 1/2"	16.70	A45557
FLAT FACE 		HEM	8	16	8	12	130	5 1/8"	14.55	A45312
		HEM	8	16	8	14	140	5 1/2"	16.70	A45314
		HEM	8	16	10	14	140	5 1/2"	16.70	A45569
		HEM	8	16	8	16	146	5 3/4"	17.00	A45316
		HEM	8	16	8	16	152 *	6"	17.60	A45378
		HEM	8	16	10	16	165 *	6 1/2"	19.40	A45560
FLAT FACE 		HEM	9	16	9	14	135	5 5/16"	16.10	A45683
		HEM	9	16	9	14	140	5 1/2"	16.70	A45681
CONCAVE 		HEM	8	16	8	12	127	5"	13.56	A45311
		HEM	8	16	8	12	130	5 1/8"	14.55	A45313
		HEM/BAL	8	16	6	16	130	5 1/8"	14.80	A45487
		BAL	8	16	6	16	130	5 1/8"	14.80	A45505
		HEM/BAL	8	16	6	16	135	5 5/16"	15.00	A45489
		HEM	8	16	8	14	140	5 1/2"	16.50	A45315
		HEM/BAL	8	16	8	14	140	5 1/2"	16.50	A45564
		HEM	8	16	8	16	146	5 3/4"	16.80	A45317
		HEM/BAL	8	16	8	16	146	5 3/4"	16.80	A45490
		HEM	8	16	9	16	152 *	6"	17.10	A45379
		HEM	8	16	9	16	165 *	6 1/2"	18.80	A45530
		HEM	10	16	12	16	180 *	7"	19.40	A45541
CONCAVE 		HEM/BAL	9	16	9	14	130	5 1/8"	15.80	A45669
		HEM	9	14	9	14	135	5 5/16"	16.10	A45631
		HEM/BAL	9	14	9	14	135	5 5/16"	16.10	A45630
		HEM/BAL	9	16	9	14	150	5 7/8"	17.60	A45670
		HEM/BAL	9	16	9	16	152 *	6"	17.60	A45544
Blow tube / Fußventil Soupage inférieure / Válvula de pie									A45116	

HEM = Hemispherical button / Kugelstift / Boutons hémisphériques / Botones esféricos

BAL = Ballistic carbide / Parabolstift / Boutons paraboliques / Botones parabólicos

CON = Conical carbide on request / Deltastift auf Anfrage / Boutons delta sur demande / Botones conicos a solicitud

MP = MultiPoint carbide on request / MultiPoint Stift auf Anfrage / Boutons MultiPoint sur demande / Botones MultiPoint a solicitud

\* = No shank breakage warranty / Keine Garantie gegen Schaftbruch / Pas de garantie en cas de rupture du tige / Ninguna garantía en caso de rotura de la varilla

# INGERSOLL-RAND DHD 360 / DH6 / SF6 / SF6.5 ROCKMORE ROK 60-360 / ROK 65-360

EPIROC COP 64 / DHD 6 / TERRANOX 6, BULROC HYPER 61 / 63 / 63 HD / 66 DH (DHD 360 shank),  
HALCO DOMINATOR 600 (DHD 360 shank) / SUPER DOMINATOR 600 / 650 (DHD 360 shank), MINCON 6 DH 360,  
NUMA CHALLENGER 6 / PATRIOT 60W, PUMA 6.2 / 6.3 (DHD 360 shank), SECOROC 6" / 6" Q / 6" QHD

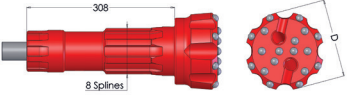
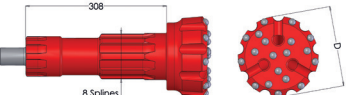
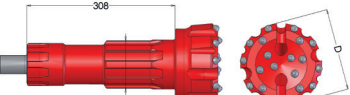
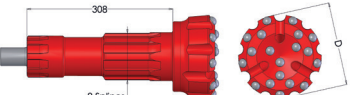
Head design Kopfdesign Façon de tête Tipo de cara	Illustration Bild Illustration Ilustración	Carbide dimension / Hartmetallabmessung Dimension métal dur / Dimension metal duro				D		Weight Gewicht Poids Peso [kg]	Part No. Artikel Nr. N° de réf. Cat. N°	
		Carbide design	Gauge/Umfang extérieur/exterior [No.] [mm]		Front/Stirnseite front/frontal [No.] [mm]		[mm]			[in]
FLAT FACE 	9.01	HEM	8	16	8	16	152	6"	23.90	A41297
		HEM	8	16	8	16	156	6 1/8"	24.30	A41206
		HEM	8	16	8	16	159	6 1/4"	24.70	A41208
		HEM	8	16	10	16	165	6 1/2"	25.20	A41209
		HEM HD	10	16	10	16	165	6 1/2"	25.40	A41296
		HEM HD	10	16	10	16	172	6 3/4"	25.90	A41213
		HEM HD	10	16	12	16	180 *	7"	25.00	A45277
		HEM HD	10	19	14	16	190 *	7 1/2"	29.80	A45348
		HEM HD	10	19	14	16	200 *	7 7/8"	30.00	A45350
		HEM HD	10	19	14	16	203 *	8"	30.10	A41214
FLAT FACE 		HEM/BAL	9	16	10	16	178 *	7"	25.00	A45626
CONCAVE 		HEM	8	16	9	16	152	6"	23.60	A41290
	HEM	8	16	9	16	156	6 1/8"	24.00	A41210	
	HEM	8	16	9	16	159	6 1/4"	24.40	A41286	
	HEM	8	16	9	16	165	6 1/2"	24.80	A41291	
	HEM HD	10	16	10	16	165	6 1/2"	25.00	A41257	
	HEM	8	19	9	16	172	6 3/4"	25.60	A45436	
	HEM HD	10	16	10	16	172	6 3/4"	25.60	A41258	
	BAL	10	16	10	16	172	6 3/4"	25.60	A45435	
	HEM HD	10	19	14	16	190 *	7 1/2"	29.80	A45349	
	HEM HD	10	19	14	16	200 *	7 7/8"	29.90	A45351	
	HEM HD	10	19	14	16	203 *	8"	30.00	A41259	
	HEM HD	12	19	23	16	254 *	10"	35.20	A45440	
	CONCAVE 		HEM HD	9	19	10	19	178 *	7"	25.60
Blow tube / Fußventil Soupape inférieure / Válvula de pie									A45095	

HEM = Hemispherical button / Kugelstift / Boutons hémisphériques / Botones esféricos

BAL = Ballistic carbide / Parabolstift / Boutons paraboliques / Botones parabólicos

CON = Conical carbide on request / DeltaStift auf Anfrage / Boutons delta sur demande / Botones conicos a solicitud

MP = MultiPoint carbide on request / MultiPoint Stift auf Anfrage / Boutons MultiPoint sur demande / Botones MultiPoint a solicitud

\* = No shank breakage warranty / Keine Garantie gegen Schaftbruch / Pas de garantie en cas de rupture du tige / Ninguna garantía en caso de rotura de la varilla

## INGERSOLL-RAND QL6 / QL60, ROCKMORE ROK 600A / ROK 650A / ROK 650M

EPIROC QL 60 / TD 60 / TD 65 / TD 70 / COP 64 GOLD, BULROC HYPER 66 DH (QL 60 shank), HALCO SUPER DOMINATOR 650 HD QL60  
 MINCON 6 DH / 6 DH-LV / XP60 / 6 BH / MP60 / MP65 / MQ68, NUMA PATRIOT 60 WQ, PUMA 6.2 (QL 60 shank), SANDVIK RH460 6" / RH460g 6"

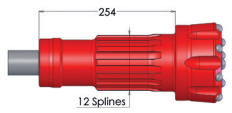
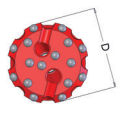
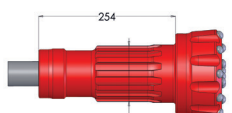
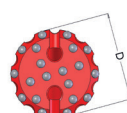
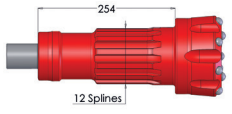
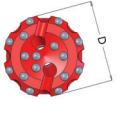
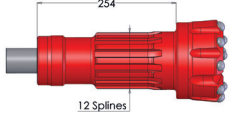
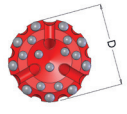
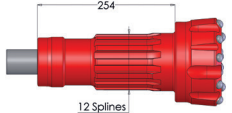
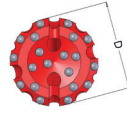
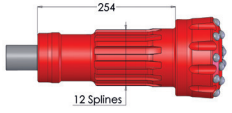
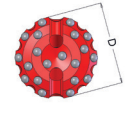
Head design Kopfdesign Façon de tête Tipo de cara	Illustration Bild Illustration Ilustración	Carbide dimension / Hartmetallabmessung Dimension métal dur / Dimension metal duro				D		Weight Gewicht Poids Peso [kg]	Part No. Artikel Nr. N° de réf. Cat. N°	
		Carbide design	Gauge/Umfang extérieur/exterior		Front/Stirnseite front/frontal		[mm]			[in]
			[No.]	[mm]	[No.]	[mm]				
<b>FLAT FACE</b> 	<b>10.01</b> 	HEM	8	16	8	16	152	6"	23.90	A45235
		HEM	8	16	8	16	155	6.1"	24.00	A45380
		HEM	8	16	8	16	156	6 1/8"	24.10	A45382
		HEM	8	16	8	16	159	6 1/4"	24.15	A45384
		HEM	8	16	10	16	165	6 1/2"	25.20	A45236
		HEM HD	8	19	10	16	165	6 1/2"	25.25	A45473
		HEM	8	19	10	16	172	6 3/4"	25.70	A45237
		HEM HD	8	19	8	19	172	6 3/4"	25.75	A45474
<b>FLAT FACE / HD</b> 		HEM	10	16	10	16	165	6 1/2"	25.40	A45241
		HEM	10	16	10	16	172	6 3/4"	25.90	A45242
		HEM	10	19	14	16	190 *	7 1/2"	26.50	A45386
		HEM	10	19	14	16	200 *	7 7/8"	27.00	A45388
		HEM	10	19	14	16	203 *	8"	31.80	A45421
		HEM	10	19	14	16	219 *	8 5/8"	32.00	A45491
		HEM	12	19	23	16	244 *	9 5/8"	51.00	A45521
<b>CONCAVE</b> 		HEM	8	16	9	16	152	6"	23.60	A45238
		HEM	8	16	9	16	155	6.1"	25.10	A45381
		HEM	8	16	9	16	156	6 1/8"	25.20	A45383
		HEM	8	16	9	16	159	6 1/4"	25.30	A45385
		HEM	8	16	9	16	165	6 1/2"	25.70	A45239
		HEM HD	8	19	9	16	165	6 1/2"	25.73	A45475
		HEM	8	19	9	16	172	6 3/4"	25.90	A45240
<b>CONCAVE</b> 		HEM	9	19	9	16	152	6"	23.65	A45445
		HEM	9	19	9	16	155	6.1"	25.15	A45446
		HEM	9	19	9	16	156	6 1/8"	25.25	A45447
		HEM	9	19	10	16	159	6 1/4"	25.35	A45448
		HEM	9	19	10	16	165	6 1/2"	25.75	A45449
		HEM	9	19	10	16	172	6 3/4"	25.95	A45450
<b>CONCAVE</b> 		HEM HD	10	16	10	16	165	6 1/2"	25.00	A45243
		HEM HD	10	19	12	16	165	6 1/2"	25.80	A45476
		HEM HD	10	16	10	16	172	6 3/4"	25.70	A45244
		HEM HD	10	19	10	16	172	6 3/4"	25.97	A45477
		HEM HD	10	16	12	16	180 *	7"	26.00	A45470
		HEM HD	10	19	14	16	190 *	7 1/2"	26.00	A45387
		HEM HD	10	19	14	16	200 *	7 7/8"	26.50	A45389
		HEM HD	10	19	14	16	220 *	8 5/8"	27.00	A45518
		HEM HD	10	16	10	16	152	6"	23.65	A45451
<b>CONCAVE-CONVEX</b> 		HEM HD	10	16	10	16	155	6.1"	25.15	A45452
		HEM HD	10	16	10	16	156	6 1/8"	25.25	A45453
		HEM HD	10	16	10	16	159	6 1/4"	25.35	A45454
		HEM HD	10	16	10	16	165	6 1/2"	25.75	A45455
		HEM HD	10	16	10	16	172	6 3/4"	25.95	A45456
		HEM HD	10	19	9	16	172	6 3/4"	25.95	A45478
		HEM HD	10	19	8	19	172	6 3/4"	26.00	A45479
		HEM HD	10	19	8	19	172	6 3/4"	26.00	A45479

Blow tube / Fußventil  
 Soupape inférieure / Válvula de pie

A45097

HEM = Hemispherical button / Kugelstift / Boutons hémisphériques / Botones esféricos  
 BAL = Ballistic carbide / Parabolstift / Boutons paraboliques / Botones parabólicos  
 CON = Conical carbide on request / Deltastift auf Anfrage / Boutons delta sur demande / Botones conicos a solicitud  
 MP = MultiPoint carbide on request / MultiPoint Stift auf Anfrage / Boutons MultiPoint sur demande / Botones MultiPoint a solicitud  
 \* = No shank breakage warranty / Keine Garantie gegen Schaftbruch / Pas de garantie en cas de rupture du tige / Ninguna garantía en caso de rotura de la varilla



# INGERSOLL-RAND DHD 380 ROCKMORE ROK 87A-380

EPIROC COP 84 / DHD 8 / TERRANOX 8, BULROC HYPER 81 (DHD 380 shank), HALCO MACH 80 / 88 (DHD 380 shank), DOMINATOR 800 / 880 / 880 DW (DHD 380 shank)  
MINCON 8 DH / XP90 - 380, NUMA CHALLENGER 80 / PATRIOT 80, PUMA 8.1 (DHD 380 shank), SECOROC 8\*

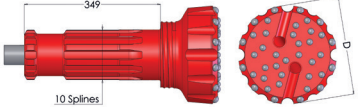
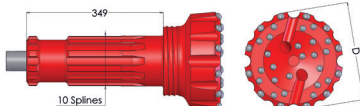
Head design Kopfdesign Façon de tête Tipo de cara	Illustration Bild Illustration Ilustración	Carbide dimension / Hartmetallabmessung Dimension métal dur / Dimension metal duro				D		Weight Gewicht Poids Peso	Part No. Artikel Nr. N° de réf. Cat. N°	
		Carbide design	Gauge/Umfang extérieure/exterior [No.] [mm]	Front/Stirnseite front/frontal [No.] [mm]		[mm]	[in]			
FLAT FACE 	11.01	HEM	10	19	14	16	203	8"	50.00	A45221
		HEM	10	19	14	16	207	8 1/8"	50.30	A45362
		HEM	10	19	14	16	216	8 1/2"	52.00	A45222
		HEM	10	19	16	16	225	8 7/8"	52.50	A45364
		HEM	10	19	16	16	229	9"	52.65	A45366
		HEM	12	19	23	16	251 *	9 7/8"	55.50	A45368
		HEM	12	19	27	16	254 *	10"	56.00	A45223
		HEM	12	19	37	16	305 *	12"	85.00	A45618
CONCAVE 		HEM	10	19	14	16	190	7 1/2"	50.00	A45432
		HEM	10	19	14	16	194	7 5/8"	49.00	A45464
		HEM	10	19	14	16	203	8"	50.00	A45224
		HEM	10	19	14	16	207	8 1/8"	50.30	A45363
		HEM	10	19	14	16	216	8 1/2"	52.00	A45225
		HEM	10	19	16	16	225	8 7/8"	52.50	A45365
		HEM	10	19	16	16	229	9"	52.65	A45367
		HEM	12	19	23	16	251 *	9 7/8"	55.50	A45369
		HEM	12	19	23	16	254 *	10"	56.00	A45226
		HEM	12	19	31	16	305 *	12"	85.00	A45617

Blow tube / Fußventil  
Soupape inférieure / Válvula de pie

A45115

# INGERSOLL-RAND QL8 / QL80 ROCKMORE ROK 800A / ROK 875A

EPIROC QL 80 / TD 80 / TD 85, BULROC HYPER 81 (QL 80 shank), HALCO DOMINATOR 850 QL80, MINCON 8.1 (QL80 shank) / MP80 / MQ80 / MP85 / MQ85,  
PUMA 8.1 (QL80 shank), SANDVIK RH460 8" / RH460g 8"

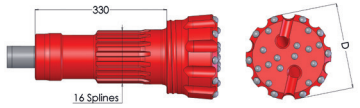
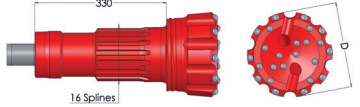
FLAT FACE 	11.02	HEM	10	19	14	16	203	8"	48.86	A45318
		HEM	10	19	14	16	216	8 1/2"	51.72	A45320
		HEM	12	19	27	16	254 *	10"	64.30	A45322
		HEM	12	19	37	16	305 *	12"	85.00	A45620
CONCAVE 		HEM	10	19	14	16	203	8"	48.86	A45319
		HEM	10	19	14	16	207	8 1/8"	48.93	A45390
		HEM	10	19	14	16	216	8 1/2"	49.10	A45321
		HEM	10	19	16	16	225	8 7/8"	52.70	A45391
		HEM	10	19	16	16	229	9"	53.10	A45392
		HEM	12	19	23	16	254 *	10"	64.30	A45323
HEM	12	19	31	16	305 *	12"	85.00	A45619		

Blow tube / Fußventil  
Soupape inférieure / Válvula de pie

A45117

HEM = Hemispherical button / Kugelstift / Boutons hémisphériques / Botones esféricos

BAL = Ballistic carbide / Parabolstift / Boutons paraboliques / Botones parabólicos

CON = Conical carbide on request / Deltastift auf Anfrage / Boutons delta sur demande / Botones conicos a solicitud

MP = MultiPoint carbide on request / MultiPoint Stift auf Anfrage / Boutons MultiPoint sur demande / Botones MultiPoint a solicitud

\* = No shank breakage warranty / Keine Garantie gegen Schaftbruch / Pas de garantie en cas de rupture du tige / Ninguna garantía en caso de rotura de la varilla

## MISSION MI6 / M60

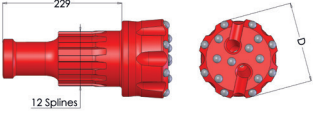
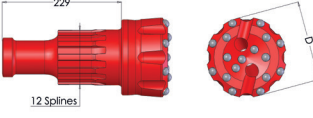
Head design Kopfdesign Façon de tête Tipo de cara	Illustration Bild Illustration Ilustración	Carbide dimension / Hartmetallabmessung Dimension métal dur / Dimension metal duro				D		Weight Gewicht Poids Peso [kg]	Part No. Artikel Nr. N° de réf. Cat. N°	
		Carbide design	Gauge/Umfang exterieur/exterior [No.] [mm]		Front/Stirnseite front/frontal [No.] [mm]		[mm]			[in]
FLAT FACE 	12.01	HEM	8	16	8	16	156	6 1/8"	20.40	A45708
		HEM HD	10	19	14	16	203 *	8"	29.50	A45709
CONCAVE 		HEM	8	16	9	16	156	6 1/8"	20.20	A45356
		HEM	8	16	9	16	165	6 1/2"	20.90	A45358
		HEM	8	16	9	16	172	6 3/4"	21.60	A45361

## MISSION A 53-15 / SD6

EPIROC COP 64M, BULROC BR6, HALCO DOMINATOR 600 (SD6 shank) SUPER DOMINATOR 650, (SD6 shank)  
MINCON 6 DHSD6, PUMA 6.2 / 6.3 (SD 6 shank), SECOROC 6" M

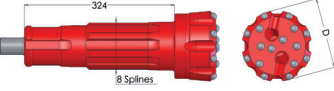
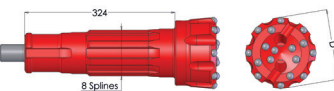
FLAT FACE 	12.02	HEM	8	16	8	16	152	6"	25.90	A45003
		HEM	8	16	8	16	156	6 1/8"	26.40	A45010
		HEM	8	16	8	16	159	6 1/4"	27.00	A45011
		HEM	8	16	10	16	165	6 1/2"	27.40	A45037
		HEM HD	10	16	10	16	165	6 1/2"	27.60	A45015
		HEM HD	10	16	10	16	172	6 3/4"	28.00	A45016
		HEM HD	10	16	10	16	178 *	7"	28.10	A45042
		HEM HD	10	19	14	16	190 *	7 1/2"	28.20	A45024
		HEM HD	10	19	14	16	200 *	7 7/8"	28.45	A45026
		HEM HD	10	19	14	16	203 *	8"	33.50	A45017
CONCAVE 		HEM	8	16	9	16	152	6"	25.90	A45012
		HEM	8	16	9	16	156	6 1/8"	26.40	A45013
		HEM	8	16	9	16	159	6 1/4"	27.00	A45014
		HEM	8	16	9	16	165	6 1/2"	27.40	A45038
		HEM HD	10	16	10	16	165	6 1/2"	27.60	A45018
		HEM HD	10	16	10	16	172	6 3/4"	28.10	A45019
		HEM HD	10	16	10	16	178 *	7"	27.70	A45043
		HEM HD	10	19	14	16	190 *	7 1/2"	28.00	A45025
		HEM HD	10	19	14	16	200 *	7 7/8"	28.20	A45027
		HEM HD	10	19	14	16	203 *	8"	33.50	A45020
Blow tube / Fußventil Soupape inférieure / Válvula de pie									A45036	

HEM = Hemispherical button / Kugelstift / Boutons hémisphériques / Botones esféricos

BAL = Ballistic carbide / Parabolstift / Boutons paraboliques / Botones parabólicos

CON = Conical carbide on request / Deltastift auf Anfrage / Boutons delta sur demande / Botones conicos a solicitud

MP = MultiPoint carbide on request / MultiPoint Stift auf Anfrage / Boutons MultiPoint sur demande / Botones MultiPoint a solicitud

\* = No shank breakage warranty / Keine Garantie gegen Schaftbruch / Pas de garantie en cas de rupture du tige / Ninguna garantía en caso de rotura de la varilla

# ROCKMORE RM250

## ROCKMORE ROK 250

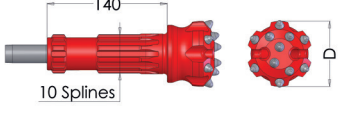
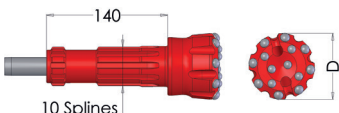
Head design Kopfdesign Façon de tête Tipo de cara	Illustration Bild Illustration Ilustración	Carbide dimension / Hartmetallabmessung Dimension métal dur / Dimension metal duro				D		Weight Gewicht Poids Peso	Part No. Artikel Nr. N° de réf. Cat. N°	
		Carbide design	Gauge/Umfang extérieur/exterior [No.] [mm]		Front/Stirnseite front/frontal [No.] [mm]		[mm]			[in]
CONVEX 	13.01	CON	6	10	5	10	72	2 13/16"	2.60	A45615
		CON	6	10	5	10	76	3"	3.00	A45570
CONCAVE 		HEM	8	11	6	10	76	3"	2.60	A45616
		HEM	8	11	6	11	89	3 1/2"	3.70	A45651
Blow tube / Fußventil Soupape inférieure / Válvula de pie									A45118	

### DTH Reaming Bits / Erweiterungstieflochbohrkronen

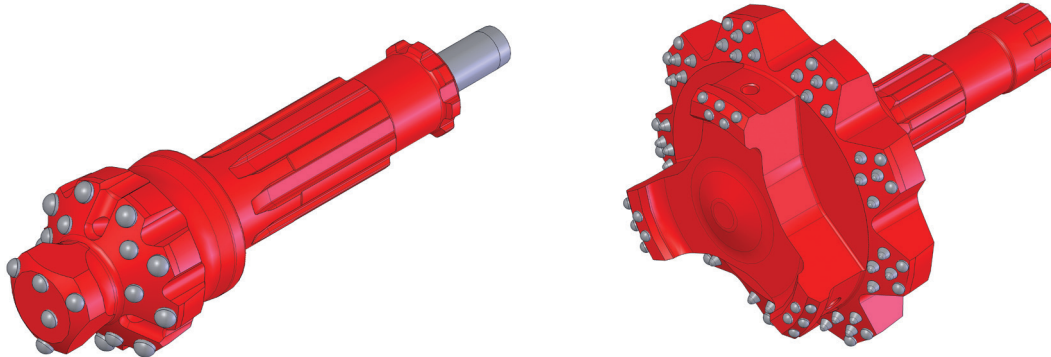

For further information, please contact our ROCKMORE representative for a quote.  
Für mehr Informationen kontaktieren Sie bitte unsere ROCKMORE-Vertretung.

HEM = Hemispherical button / Kugelstift / Boutons hémisphériques / Botones esféricos  
BAL = Ballistic carbide / Parabolstift / Boutons paraboliques / Botones parabólicos  
CON = Conical carbide on request / Deltastift auf Anfrage / Boutons delta sur demande / Botones conicos a solicitud  
MP = MultiPoint carbide on request / MultiPoint Stift auf Anfrage / Boutons MultiPoint sur demande / Botones MultiPoint a solicitud